



# N-R-G-FLOOR<sup>+</sup> TAPMATE 6 PRESET

INNOVATIVE FLOOR SOLUTIONS<sup>®</sup>

## PARTS CATALOG TAPMATE 6 SERIES

envision | design | support | expand | strengthen

# PREFACE

This catalog has been prepared to simplify specifying and ordering the necessary component parts for Cordeck's Tapmate 6 Preset Outlet Boxes.

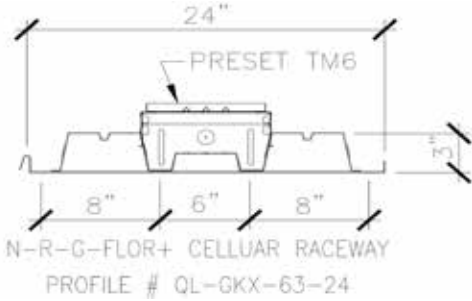

Tapmate 6 Present  
~ 2019 - Current

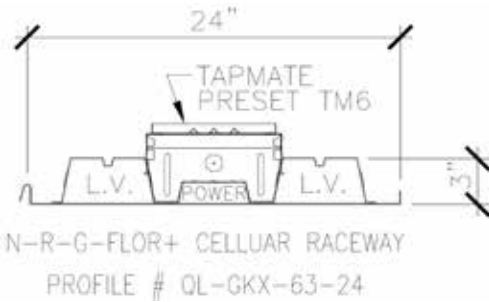

Center Power Design  
~ Large outboard cells contain low voltage cables  
~ Small center cell contains power wires

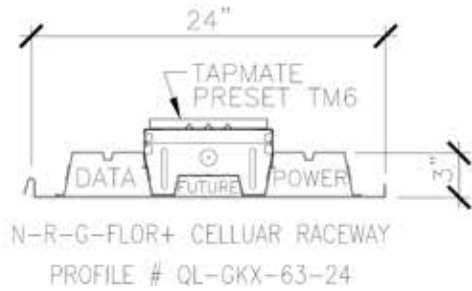

Side Power Design  
~ One large outboard cell contains low voltage cables  
~ One large outboard cell contains power wires  
~ Small center cell may contain either low voltage or power

# CONTENTS

Cover Plates. . . . .	p.3	Partition Feed - Center Power Assembly C. . . . .	p.8-9
Point of Use - Side Power Assembly A. . . . .	p.4-5	Partition Feed - Side Power Assembly D. . . . .	p.10-11
Point of Use - Center Power Assembly B. . . . .	p.6-7	Parts Identification. . . . .	p.12

# COVER PLATES

## KED-MC Aluminum Cover Assembly

### Part Numbers

Powder Coated

KED-MC Black Satin

KED-MC Brushed Nickel

KED-MC Charcoal

KED-MC Oil Rubbed Bronze

Anodized

KED-MC Silver

KED-MC Bronze



## KED-NAC Lexan Cover Assembly

### Part Numbers

KED-NAC Black

KED-NAC Brown

KED-NAC Gray



## KED-SC8 Three Piece Aluminum Cover

### Part Numbers

Mill Finished Aluminum

KED-SC8



## KEC-PC-5/6 Three Piece Lexan Cover

### Part Numbers

KEC-PC5-Black

KEC-PC5-Brown

KEC-PC5-Gray

KEC-PC6-Black

KEC-PC6-Brown

KEC-PC6-Gray





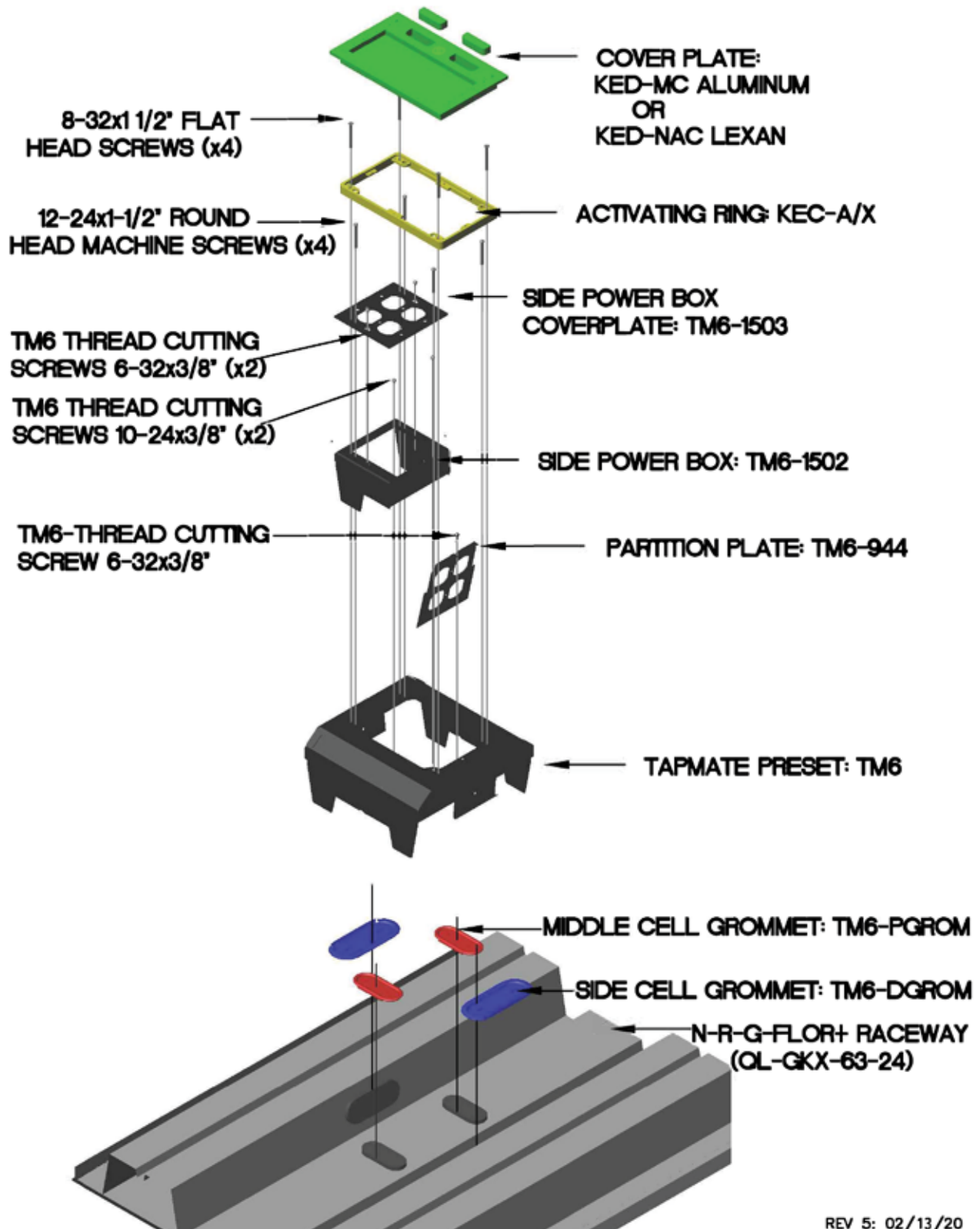







# TAPMATE 6 POINT OF USE SIDE POWER ASSEMBLY A



REV 5: 02/13/20

# TAPMATE 6 POINT OF USE SIDE POWER ASSEMBLY A

PART	DESCRIPTION/SPECIFICATIONS	PART	DESCRIPTION/SPECIFICATIONS										
<p><b>KED-MC</b></p> 	<p><b>COVER PLATE</b></p> <p><i>Color Options</i></p> <table border="0"> <tr> <td><i>Powder Coated</i></td> <td><i>Anodized</i></td> </tr> <tr> <td>KED-MC Black Satin</td> <td>KED-MC Silver</td> </tr> <tr> <td>KED-MC Brushed Nickel</td> <td>KED-MC Bronze</td> </tr> <tr> <td>KED-MC Charcoal</td> <td></td> </tr> <tr> <td>KED-MC Oil Rubbed Bronze</td> <td></td> </tr> </table>	<i>Powder Coated</i>	<i>Anodized</i>	KED-MC Black Satin	KED-MC Silver	KED-MC Brushed Nickel	KED-MC Bronze	KED-MC Charcoal		KED-MC Oil Rubbed Bronze		<p><b>TM6-1502</b></p> 	<p><b>SIDE POWER BOX</b></p>
<i>Powder Coated</i>	<i>Anodized</i>												
KED-MC Black Satin	KED-MC Silver												
KED-MC Brushed Nickel	KED-MC Bronze												
KED-MC Charcoal													
KED-MC Oil Rubbed Bronze													
<p><b>KED-NAC</b></p> 	<p><b>COVER PLATE</b></p> <p><i>Color Options</i></p> <ul style="list-style-type: none"> <li>KED-NAC Black</li> <li>KED-NAC Brown</li> <li>KED-NAC Gray</li> </ul>	<p><b>TM6-1503</b></p> 	<p><b>SIDE POWER BOX COVER PLATE</b></p>										
<p><b>KEC-A/X</b></p> 	<p><b>ACTIVATION RING</b></p>	<p><b>N-R-G-FLOR+</b></p> 	<p><b>RACEWAY</b></p> <p><i>Profile:</i></p> <p>QL-GKX-63-24</p>										
<p><b>TM6-944</b></p> 	<p><b>PARTITION PLATE</b></p>	<p><b>TM6-PGROM</b></p> 	<p><b>POWER CELL GROMMET</b></p>										
<p><b>TM6</b></p> 	<p><b>TAPMATE 6 PRESET</b></p>	<p><b>TM6-DGROM</b></p> 	<p><b>SIDE CELL GROMMET</b></p>										

# TAPMATE 6 POINT OF USE CENTER POWER ASSEMBLY B

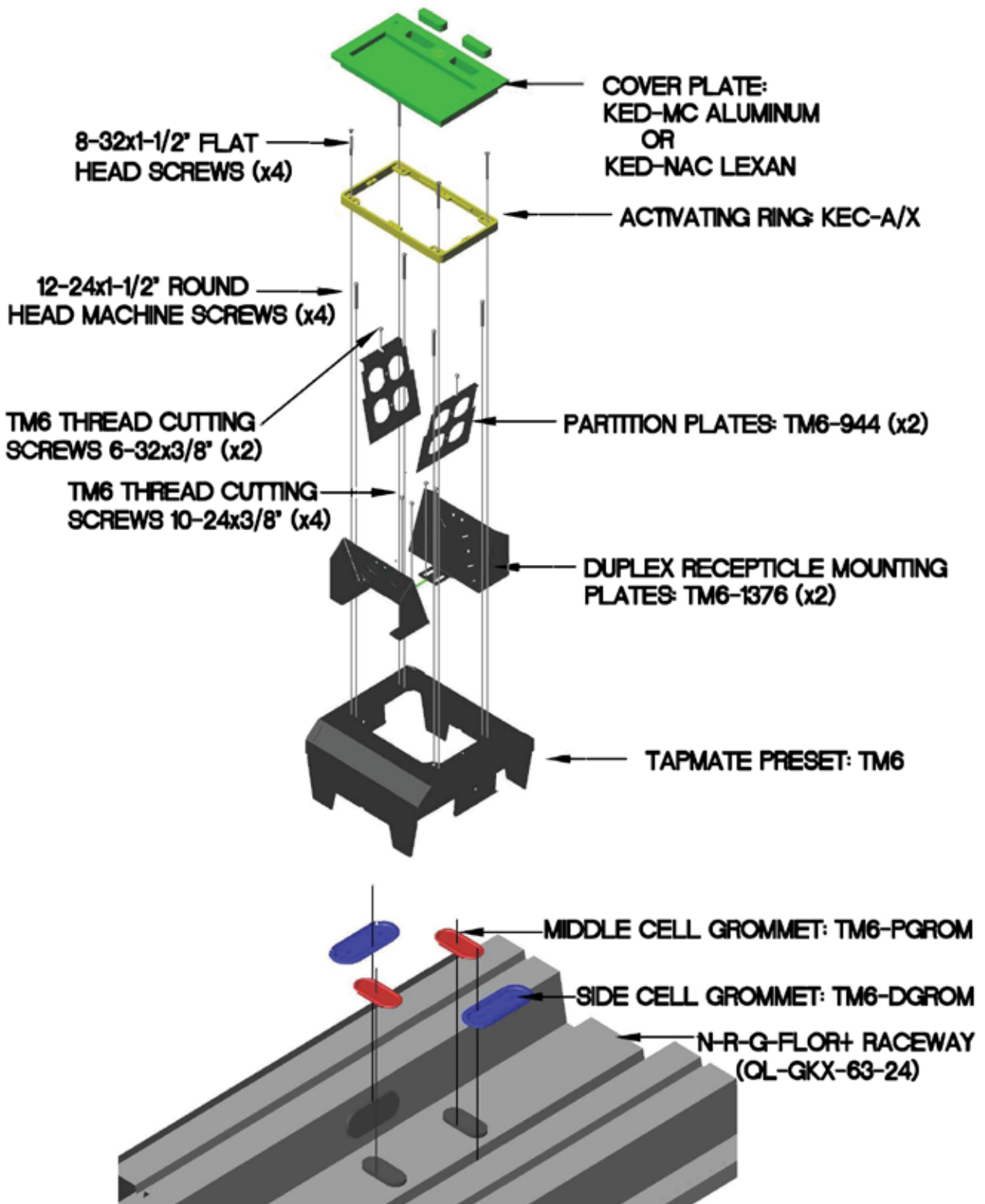

REV 5: 02/13/20

# TAPMATE 6 POINT OF USE CENTER POWER ASSEMBLY B

**PART DESCRIPTION/SPECIFICATIONS**

**KED-MC COVER PLATE**

*Color Options*

<i>Powder Coated</i>	<i>Anodized</i>
KED-MC Black Satin	KED-MC Silver
KED-MC Brushed Nickel	KED-MC Bronze
KED-MC Charcoal	
KED-MC Oil Rubbed Bronze	



**KED-NAC COVER PLATE**

*Color Options*

- KED-NAC Black
- KED-NAC Brown
- KED-NAC Gray



**KEC-A/X ACTIVATING RING**



**TM6-944 PARTITION PLATES**



**TM6 TAPMATE 6 PRESET**



**PART DESCRIPTION/SPECIFICATIONS**

**TM6-1376 DUPLEX RECEPTICLE MOUNT PLATES**



**N-R-G-FLOOR+ RACEWAY**

Profile:  
QL-GKX-63-24



**TM6-PGROM POWER CELL GROMMET**



**TM6-DGROM DATA CELL GROMMET**



# TAPMATE 6 PARTITION FEED CENTER POWER ASSEMBLY C

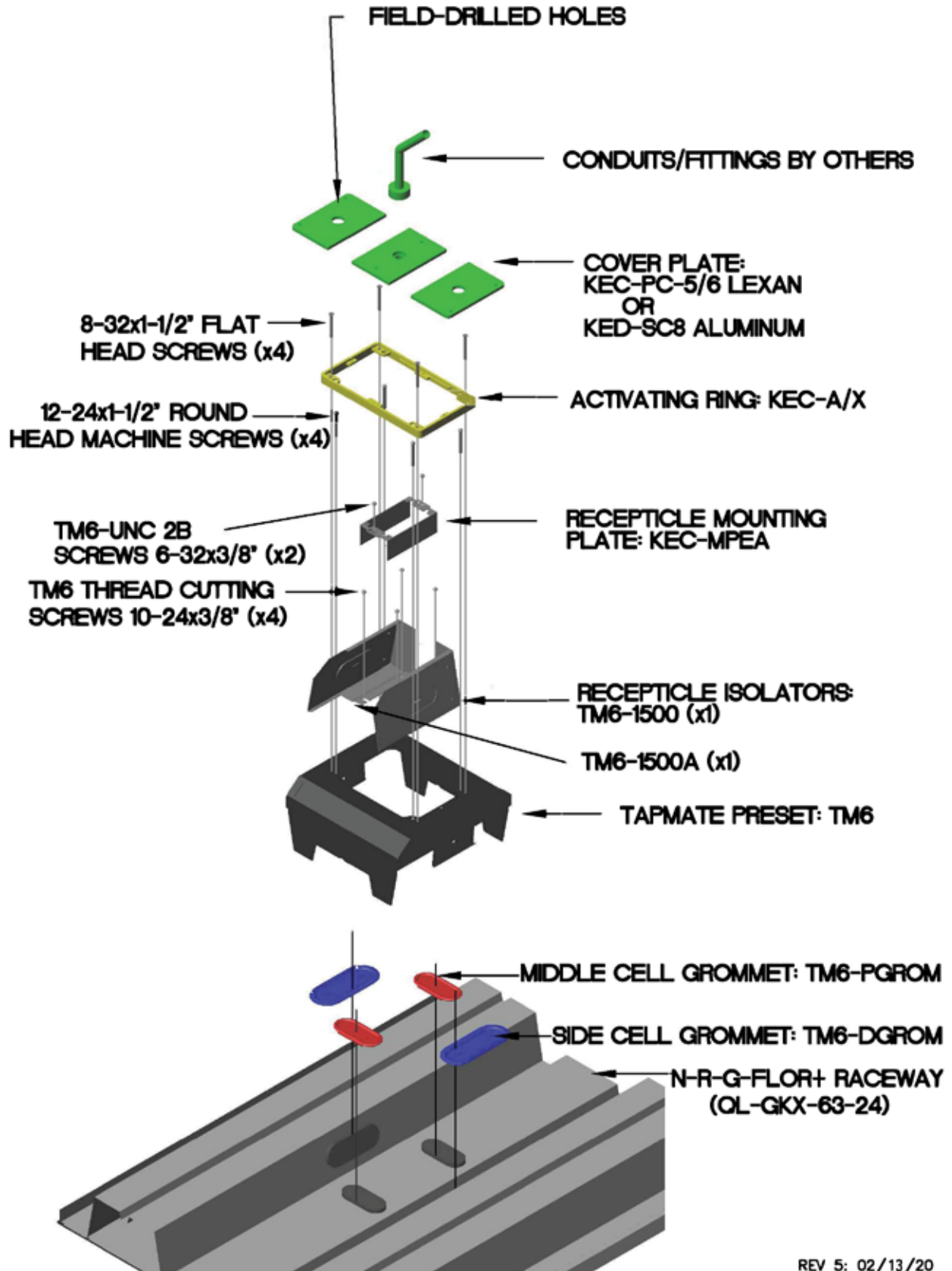

REV 5: 02/13/20



# TAPMATE 6 PARTITION FEED CENTER POWER ASSEMBLY C

**PART DESCRIPTION/SPECIFICATIONS**

**KEC-PC- 5/6 LEXAN**



**COVER PLATE**

*Color Options*

KEC-PC5 Black	KEC-PC6 Black
KEC-PC5 Brown	KEC-PC6 Brown
KEC-PC5 Gray	KEC-PC6 Gray

**PART DESCRIPTION/SPECIFICATIONS**

**TM6**



**TAPMATE 6 PRESET**

**KED-SC8**



**COVER PLATE**

*Color Options*

Mill Finished Aluminum

**TM6-PGROM**



**POWER CELL GROMMET**

**KEC-A/X**



**ACTIVATING RING**

**TM6-DGROM**



**SIDE CELL GROMMET**

**KEC-MPEA**



**RECEPTICLE MOUNTING PLATE**

**TM6-1500  
TM6-1500A**



**RECEPTICLE ISOLATORS**

**N-R-G-FLOR+**



**RACEWAY**

*Profile:*

QL-GKX-63-24

# TAPMATE 6 PARTITION FEED SIDE POWER ASSEMBLY D

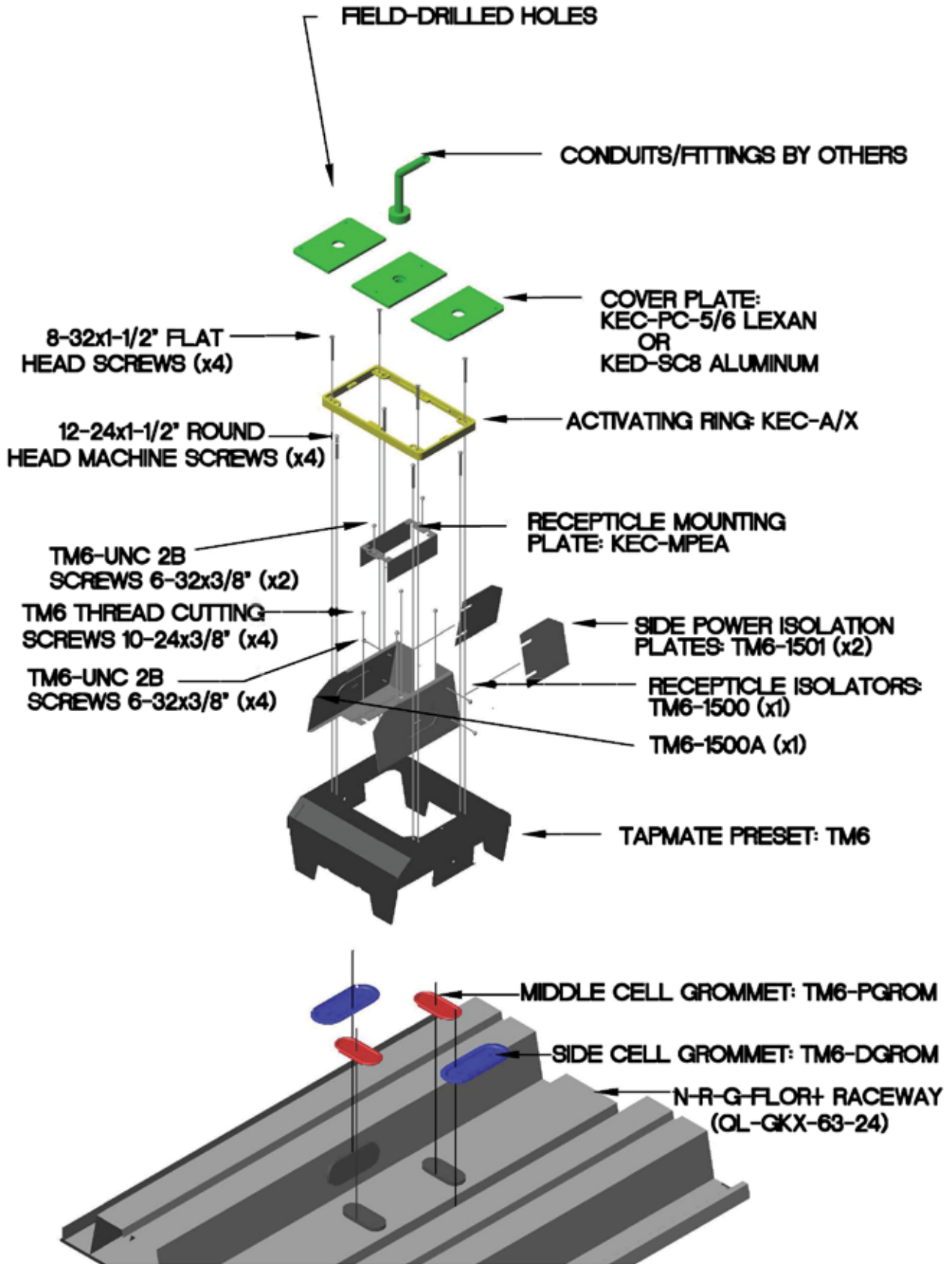

REV 5: 02/13/20

# TAPMATE 6 PARTITION FEED SIDE POWER ASSEMBLY D

**PART DESCRIPTION/SPECIFICATIONS**

**KEC-PC- 5/6 LEXAN**

**COVER PLATE**



*Color Options*

KEC-PC5 - Black      KEC-PC6 - Black  
 KEC-PC5 - Brown    KEC-PC6 - Brown  
 KEC-PC5 - Gray      KEC-PC6 - Gray

**PART DESCRIPTION/SPECIFICATIONS**

**TM6-1500  
TM6-1500 A**

**RECEPTICLE ISOLUTOR**



**KEC-SC8**

**COVER PLATE**

*Color Options*  
 Mill Finished Aluminum

 A mill-finished aluminum cover plate with four circular mounting holes, one in each corner.

**TM6-1501**

**SIDE POWER ISOLATION**

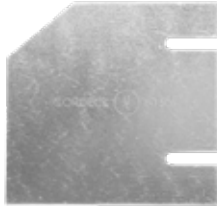
 A metal side power isolation component with a C-shaped profile and two horizontal slots.

**KEC-MPEA**

**RECEPTICLE MOUNTING PLATE**

 A metal receptacle mounting plate with a U-shaped profile and mounting holes.

**TM6-PGROM**

**POWER CELL GROMMET**

 A black power cell grommet with a rectangular shape and rounded corners.

**N-R-G-FLOR+**

**RACEWAY**

*Profile:*  
 QL-GKX-63-24

 A metal raceway profile with a U-shaped cross-section and mounting holes.

**TM6-DGROM**

**SIDE CELL GROMMET**

 A black side cell grommet with an oval shape and mounting holes.

**KEC-A/X**

**ACTIVATING RING**

 A metal activating ring with a rectangular shape and mounting holes.

**TM6**

**TAPMATE 6 PRESET**

 A metal Tapmate 6 preset component with a complex, multi-faceted shape.

# PARTS IDENTIFICATION

## Tapmate 6 Assembly A

KED-MC	Cover Plate Aluminum
KED-NAC	Cover Plate Lexan
KEC-A/X	Activating Ring
TM6-1503	Side Power Box Cover Plate
TM6-1502	Side Power Box
TM6-944	Partition Plate
TM6	Tapmate Preset
TM6-PGROM	Middle Cell Grommet
TM6-DGROM	Side Cell Grommet
QL-GKX-63-24	N-R-G-FLOR+ Deck
E534039	8-32 x 1-1/2" Flat Head Screws
E534083	12-24 x 1-1/2" Round Head Machine Screws
E534007	6-32 x 3/8" Thread Cutting Screws
TM6 Thread Cutting Screw 10-24	3/8" Thread Cutting Screws

## Tapmate 6 Assembly B

KED-MC	Cover Plate Aluminum
KED-NAC	Cover Plate Lexan
KEC-A/X	Activating Ring
TM6-944	Partition Plate
TM6-1376	Duples Recepticle Mounting Plates
TM6	Tapmate Preset
TM6-PGROM	Middle Cell Grommet
TM6-DGROM	Side Cell Grommet
QL-GKX-63-24	N-R-G-FLOR+ Deck
E534039	8-32 x 1-1/2" Flat Head Screws
E534083	12-24 x 1-1/2" Round Head Machine Screws
E534007	6-32 x 3/8" Thread Cutting Screws
TM6 Thread Cutting Screw 10-24	3/8" Thread Cutting Screws

## Tapmate 6 Assembly C

KEC-PC-5/6	Cover Plate Lexan
KED-SC8	Cover Plate Aluminum
KEC-A/X	Activating Ring
KEC-MPEA	Recepticle Mounting Plate
TM6-1500	Recepticle Isolators
TM6-1500A	Recepticle Isolators
TM6	Tapmate Preset
TM6-PGROM	Middle Cell Grommet
TM6-DGROM	Side Cell Grommet
QL-GKX-63-24	N-R-G-FLOR+ Deck
E534039	8-32 x 1-1/2" Flat Head Screws
E534083	12-24 x 1-1/2" Round Head Machine Screws
E534004	6-32 x 3/8" Undercut 2B Thread Cutting Screws
TM6 Thread Cutting Screw 10-24	3/8" Thread Cutting Screws

## Cover Plates

### KED-MC Aluminum Cover Assembly with Screws

Powder Coated	Anodized
KED-MC Black Satin	KED-MC Silver
KED-MC Brushed Nickel	KED-MC Bronze
KED-MC Charcoal	
KED-MC Oil Rubbed Bronze	

### KED-NAC Lexan Cover Assembly with Screws

KED-NAC Black
KED-NAC Brown
KED-NAC Gray

### KED-SC8 Three Piece Aluminum Cover with Screws

Mill Finished Aluminum
KED-SC8

### KEC-PC 5/6 Three Piece Lexan Cover with Screws

KEC-PC5 Black	KEC-PC6 Black
KEC-PC5 Brown	KEC-PC6 Brown
KEC-PC5 Gray	KEC-PC6 Gray

## Tapmate 6 Assembly D

KEC-PC-5/6	Cover Plate Lexan
KED-SC8	Cover Plate Aluminum
KEC-A/X	Activating Ring
KEC-MPEA	Recepticle Mounting Plate
TM6-1501	Side Power Isolatiotn Plates
TM6-1500	Recepticle Isolators
TM6-1500A	Recepticle Isolators
TM6	Tapmate Preset
TM6-PGROM	Middle Cell Grommet
TM6-DGROM	Side Cell Grommet
QL-GKX-63-24	N-R-G-FLOR+ Deck
E534039	8-32 x 1-1/2" Flat Head Screws
E534083	12-24 x 1-1/2" Round Head Machine Screws
E534004	6-32 x 3/8" Undercut 2B Thread Cutting Screws
TM6 Thread Cutting Screw 10-24	3/8" Thread Cutting Screws



12620 Wilmot Rd  
Kenosha, WI 53142  
877-857-6400

[cordeck.com](http://cordeck.com) | [infloorsystems@cordeck.com](mailto:infloorsystems@cordeck.com)